

OPERATIONAL MANUAL

.TYPE

- ONLINE
UNINTERRUPTIBLE
POWER SUPPLY

.POWER RANGE

- 1,000VA
- 1,500VA
- 2,000VA
- 3,000VA
- 4,000VA
- 5,000VA
- 6,000VA

English



Contents

1	INTRODUCTION	2
2	SAFETY INSTRUCTION – CAUTION	3
2.1	IMPORTANT SAFETY INSTRUCTIONS	3
2.2	Description of Commonly Used Symbols	4
3	SYSTEM DESCRIPTION	5
3.1	Front Panel	5
3.2	The LCD Display and Buttons Description	6
3.3	ON/OFF Switch	6
3.4	Config Switch	6
3.5	Enter Switch:	7
3.6	Input parameters (voltage & frequency)	7
3.7	Output parameters (voltage & frequency)	8
3.8	Bypass mode	8
3.9	Economic mode	8
3.10	Inverter mode	9
3.11	Warning and fault indicator	9
3.12	Battery capacity level	10
3.13	Load percentage indicator	10
4	INSTALLATION	18
4.1	Inspecting the Equipment	18
4.2	Placement	18
4.3	Charging	18
4.4	Load Connection	18
4.5	Modem/Phone-line Connection	18
4.6	DC Start Function	18
4.7	Turn On/Off	18
4.8	UPS Setup	18
4.9	Tower Setup	19
4.9.1	TOWER CONFIGURATION SETUP	19
4.9.2	RACK-MOUNT CONFIGURATION SETUP	20
4.9.3	LCD display cover setup	20
4.9.4	Emergency Power Off(EPO) setup	21
4.9.5	Net/Tel Connection	21
5	BATTERY REPLACEMENT	22
6	COMMUNICATION PORT	23
7	TROUBLE SHOOTING GUIDE	24
8	SPECIFICATION	25
9	SOFTWARE INSTALLATION	28

1 INTRODUCTION

This on line series UPS is an uninterruptible power supply incorporating double-conversion technology and provides perfect pure sine wave output for load specifically designed for Servers.

Adopting the double-conversion principle, this advanced UPS system eliminates all mains power disturbances. An internal rectifier converts the alternating current to direct current, and then the direct current will be used for charging the batteries and powering the internal inverter. By converting the DC voltage, the inverter generates a sinusoidal AC voltage which supplies the load without interruption. All the peripheral devices are thus powered entirely by the mains power. However, In the event of power failure, the maintenance-free batteries will power the whole system.

This manual covers the following Models of UPS. Please confirm if the model purchased is included in the following list.

Model No.	Type
S1KSL / RM1KSL	1KVA Long backup time on line UPS
S1KL / RM1KL	1KVA Inbuilt battery on line UPS
S1.5KSL / RM1.5KSL	1.5KVA Long backup time on line UPS
S1.5KL / RM1.5KL	1.5KVA Inbuilt battery on line UPS
S2KSL / RM2KSL	2KVA Long backup time on line UPS
S2KL / RM2KL	2KVA Inbuilt battery on line UPS
S3KSL / RM3KSL	3KVA Long backup time on line UPS
S3KL / RM3KL	3KVA Inbuilt battery on line UPS
S4KSL / RM4KSL	4KVA Long backup time on line UPS
S4KL / RM4KL	4KVA Inbuilt battery on line UPS
S5KSL / RM5KSL	5KVA Long backup time on line UPS
S5KL / RM5KL	5KVA Inbuilt battery on line UPS
S6KSL / RM6KSL	6KVA Long backup time on line UPS
S6KL / RM6KL	6KVA Inbuilt battery on line UPS

Features:

- ◆ Pure sine wave output
- ◆ Rotatable LCD display design
- ◆ Tower / Rack multi-configuration for flexible installation
- ◆ Microprocessor control guarantees high reliability
- ◆ Adopting high frequency full bridge topology for high steady performance
- ◆ High input power factor correction
- ◆ Selectable various output range and operating mode
- ◆ Cold start function
- ◆ Built-in dry contact/RS-232/EPO communication port
- ◆ SNMP allows for web-based remote or monitoring management
- ◆ Optional AS400 relay card
- ◆ Enable to extend runtime with scalable external battery pack
- ◆ Overload, short-circuit, and overheat protection
- ◆ Hot-swappable battery design
- ◆ 19" rack mount kit available for all models

2 SAFETY INSTRUCTION – CAUTION

2.1 IMPORTANT SAFETY INSTRUCTIONS

SAVE THESE INSTRUCTIONS - This manual contains important instructions that should be followed during installation and maintenance of the UPS and batteries.







WARNING: *Do not attempt to repair and perform service on this UPS. This UPS contains high voltages which could cause the risk of electrical shock. Even this UPS is disconnected from the electrical outlet, the dangerous voltage may still be present through the battery. All maintenance and battery replacement should be performed by qualified service personnel only.*

- a) This UPS should be placed indoors with adequate airflow and free of contamination. To install or operate it in a clean and indoor environment, free from moisture, flammable liquids, and direct sunlight. Ambient temperature range must be 0°C to 40°C (32°F to 104°F).
- 2) This UPS is designed for Commercial/Industrial use only. It is not intended for use with life support application and other designated “life-critical” devices.
- 3) Do not remove the input power cord when this UPS is turned on. This removes the safety ground from this UPS and the equipment connected to the UPS.
- 4) Turn off this UPS and disconnect input power cord before battery replacement.
- 5) The battery contains high short-circuit current. Replacing or servicing the battery which should be performed and supervised by qualified service personnel knowledgeable of batteries and required precautions.
 - a) Remove watches and jewelries
 - b) Use tools with insulated handles
 - c) Wear rubber gloves and boots.
 - d) Do not lay tools or metal parts on top of batteries.
 - e) Disconnect charging source prior to connecting or disconnecting battery terminals.
- 6) When replacing the batteries, use the appropriate replacement battery kits.
CAUTION! Replace with equal number and type of batteries is a MUST.
- 7) Do not open or mutilate the batteries. The released electrolyte is toxic and harmful to skin and eyes.
- 8) Do not dispose of batteries into fire. Battery is extremely dangerous and explosive under high temperature. Proper disposal of battery is required. Please refer to your local laws and regulations about disposal requirements.
- 9) To reduce the risk of fire, use only No. 26 AWG or larger telecommunication line cord.

-
- 10) This UPS contains high voltages which may cause the risk of electric shock. Do not remove the cover. There are no user replaceable parts inside of the UPS. Please contact your local dealer or distributor for service.
 - 11) During the installation of this equipment, it should be assured that the sum of the leakage currents of the UPS, and the connected loads does not exceed 3.5mA.
 - 12) Although disconnecting the UPS unit from the mains, hazardous voltage may still be accessible through the supply from battery. The battery supply should be therefore disconnected from the plus and minus pole of the battery when performing inside maintenance or service of the unit.
 - 13) The mains socket outlet that supplies the UPS shall be installed nearby the UPS and shall be accessible easily.

2.2 Description of Commonly Used Symbols

Some of all the following symbols may be used in this manual. It is advisable to familiarize yourself with them and understand their means:

Symbol & Description	
Symbol	Description
	Alert you to pay special attention
	Caution of high voltage
	Alternating current source(AC)
	Direct current source(DC)
	Protective ground
	Recycle
	Keep UPS in a clear area

3 SYSTEM DESCRIPTION

3.1 Front Panel

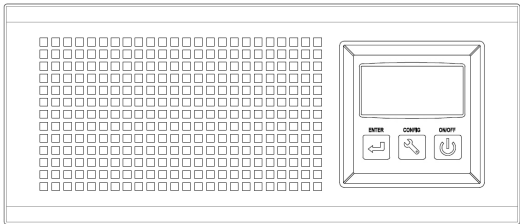

1KVA to 3KVA

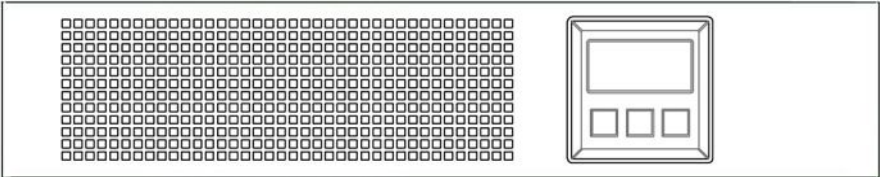

4KVA

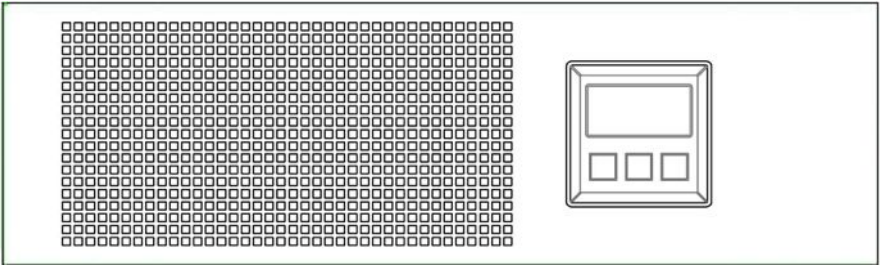

5KVA / 6KVA

3.2 The LCD Display and Buttons Description

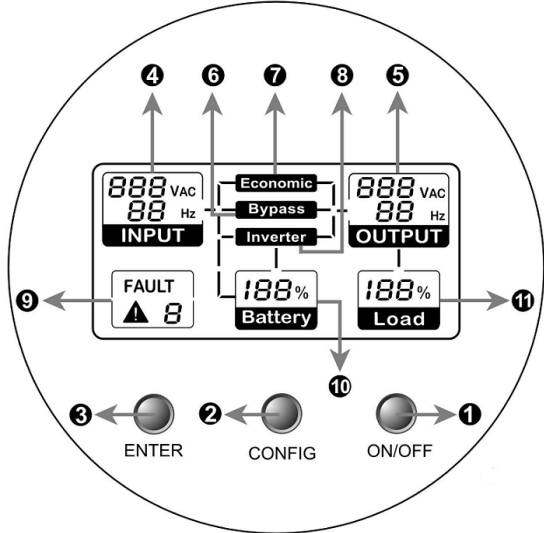

No.	Function	Description
1	On/Off Switch	For UPS on and off
2	Config. Switch	For doing the UPS parameter configuration
3	Enter Switch	To confirm the parameter setting
4	Input Information	Input parameters (voltage & frequency)
5	Output Information	Output parameters (voltage & frequency)
6	Bypass Indicator	Operating in bypass mode
7	ECO Indicator	Operating in economic mode
8	Inverter Indicator	Operating in inverter mode
9	Warning Information	Warning and fault indicators
10	Battery Information	Battery capacity level
11	Load Information	Load capacity level

3.3 ON/OFF Switch

- To turn on the UPS, press the "ON/OFF" button for more than three seconds.
- To turn off the UPS, press and hold the button until the UPS beep ceases.

3.4 Config Switch

Keeping this button pressed for three seconds, the LCD will enter the Configuration

Mode.

In the Configuration Mode, you can set ECO mode (i.e. economic mode) to be enabled or disabled, Bypass mode to be enabled or disabled, and Generator input type enabled or disabled as well. Additionally, the rated output voltage could also be changed within 220V/230V/240V.

After selecting the configuration mode, you must press the “Enter” button to confirm the selection. Please refer to the Examples for Config Mode for more detailed information.

Note:

- 1) *If neither the “Config” button nor the “Enter” button pressed within 30 seconds, the LCD system will exit from the Config Mode, and return to the original mode before the configuration.*
- 2) *The explanation for the three modes:*
 - a) **Economic mode:** *The mode is for low power consumption but is recommend to be selected only with high quality input power source.*
 - b) **Bypass mode:** *UPS supplies the load power from the utility directly.*
 - c) **Inverter mode (i.e. normal mode):** *The mode is for obtaining excellent output quality but with higher power consumption. It is also the default setting mode.*
- 3) *Generator input type: If the mode is enabled, the UPS could accept wide range input source, including frequency and waveform.*
- 4) *The default settings are Economic mode disabled, Bypass mode disabled, Generator input type disabled, and the rated output voltage is at 230V.*
- 5) *Your configuration will be memorized by UPS, which means that the default setting could be changed.*

3.5 Enter Switch:

This button has three functions.

- To confirm the selected setting in Config mode accompanying with “Config” button.
- When AC utility power is available and the battery is full charged, it is possible to perform self-test function by pressing and holding the button over five seconds.
- When UPS is not in configuration mode, keeping this button pressed less than five seconds can disable or enable the alarm buzzer. Each time a new alarm event is encountered, the alarm that will sound and press this button to turn off the alarm.

Note: *Unable to disable alarm buzzer as below conditions: Low Battery, Overload, Fan Failed, Fan Fault Time Out, and Over Temperature.*

Note:

- If any button is pressed, the back-light LCD will be on.
- In Config mode, the back-light of the LCD will be always on.
- If none of the button is touched for more than one minute, the back-light will be off automatically.
- When UPS is turned on, the back-light will be active for one minute.

3.6 Input parameters (voltage & frequency)

This part gives the information of the AC utility power, including input voltage and frequency.



The LCD panel indicates that the input voltage is 230V and the input frequency is 50Hz.

3.7 Output parameters (voltage & frequency)

This part gives the information of the output, including output voltage and output frequency.



The LCD panel indicates that the output voltage is 230V and output frequency is 50Hz.

3.8 Bypass mode

The LCD symbol  indicates that the UPS is in Bypass mode. The typical display when UPS is in bypass mode:

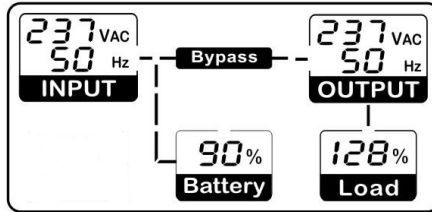

3.9 Economic mode

The LCD symbol  illuminates when UPS is in Economic mode. The typical display when UPS is in economic mode:

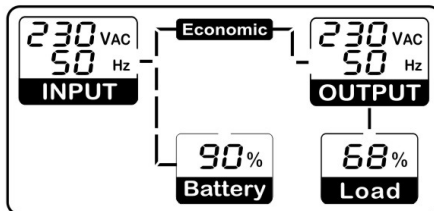





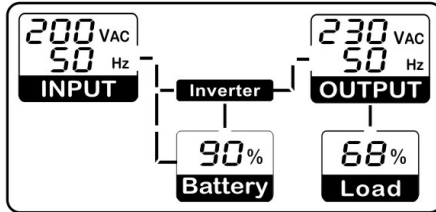



3.10 Inverter mode

The LCD symbol  illuminates when UPS is in Inverter mode (normal mode). The typical display when UPS is in inverter mode:



3.11 Warning and fault indicator

This part shows the type of failure when the UPS fails or gives warning sound.

FAILURE CODE	STATUS	DESCRIPTION
	Steady	Output short circuit
	Flash	Fan fails
	Steady	Fan fails and the time is out
	Flash	UPS is overload
	Steady	UPS is overload and the time is out
	Flash	Battery is bad or battery is disconnected
	Flash	Battery is overcharged
	Steady	Output voltage is out of range
	Flash	Over temperature alarm (In Bypass)
	Steady	Over temperature fault (Output Off)
	Steady	Inner circuitry fault

Note : If the symbol  flashes, it means the minor problem, and the output will still be normal.

If the symbol  remains on, it means the serious problem occurs, and the output may be cut off.

3.12 Battery capacity level

The battery capacity remains in percentage.



3.13 Load percentage indicator

This part shows the current load percentage in rated load of the UPS.



Examples for LCD display

- The AC source is available, and the UPS is turned on (UPS in Bypass mode, Economic mode, or Inverter mode):

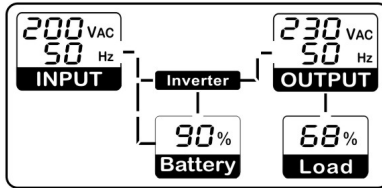

- The AC source is not present and UPS is turned on (UPS in battery mode):

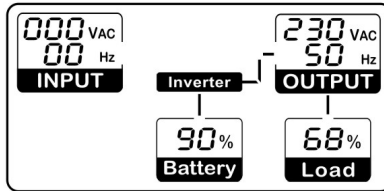

- The AC source is present but UPS doesn't be turned on (UPS in standby mode):

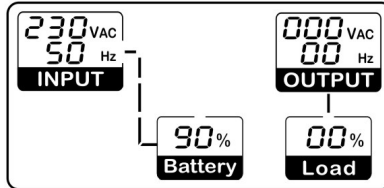

- UPS is in self test state:

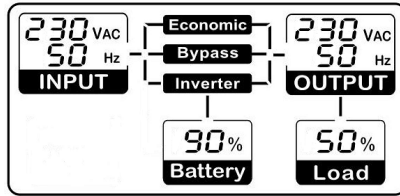

Examples for Config Mode

In the Config Mode, the below information will appear in the LCD.

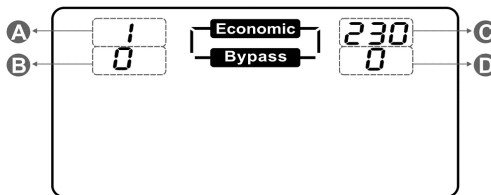

Explanation for four parts of the above figure:

Part A: This part is for the ECO mode enabled or disabled setting. Setting to 1 means ECO mode is enabled. And setting to 0 means disable ECO mode. The default setting is 0.

Part B: This part is for the Bypass mode enabled or disabled setting. Setting to 1 means the Bypass mode is enabled. Otherwise, setting to 0 means disable the Bypass mode. The default setting is 0.

Part C: This part is for the rated output voltage setting. 220V/230V/240V are supplied for selecting and setting. The default setting is 230V.

Part D: This part is for the Generator input type enabled or disabled setting. Setting to 1 means the Generator input type is enabled. Otherwise, setting to 0 means disable the Generator input type. The default setting is 0.

For example, if the original settings are as follows:

ECO mode is enabled (Part A is 1 setting), Bypass mode is disabled (Part B is 0 setting), Generator input type is disabled (Part D is 0 setting), and rated output voltage is 230V (Part C is 230 setting).

Now, if you want to change the settings to the following:

ECO mode is disabled (Part A is 0 setting), Bypass mode is enabled (Part B is 1 setting), Generator input type is enabled (Part D is 1 setting), and rated output voltage is 220V (Part C is 220 setting).

Then, the correct steps are showed below to you to follow.

Step1: Keep the Config switch pressed for 3 seconds to enter the Config mode. The original settings will appear in the LCD as below. And the first setting item (“1”) is blinking.

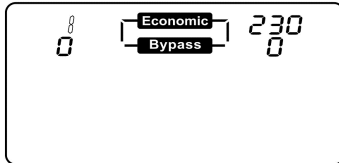

Step 2: Push the Config button to switch the option, which makes “1” switch to “0” and blink.

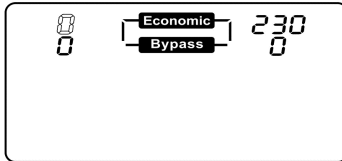

Step 3: Push the Enter button to confirm the option, and then the ECO mode is changed to be disabled. Simultaneously, the second setting item (“0”) starts to blink.

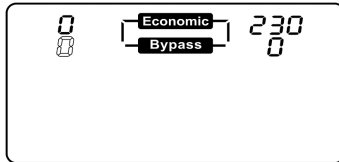

Step 4: Push the Config button to switch the option, which makes “0” switch to “1” and blink.

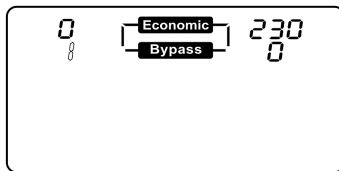

Step 5: Push the Enter button to confirm the option, and then the Bypass mode is changed to be enabled. Simultaneously, the third setting item (“230”) starts to blink.

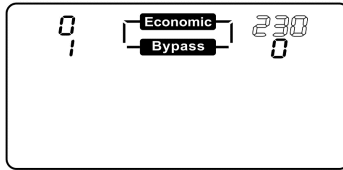

Step 6: Push the Config button to switch the option, which makes “230” switch to “240” and blink.

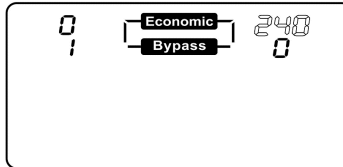

Step 7: Push the Config button again to do the second switch, which makes “240” switch to “220” and blink.

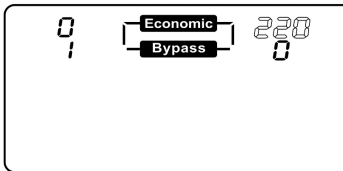

Step 8: Push the Enter button to confirm the option, and then the rated output voltage is changed to 220V. Simultaneously, the last setting item (“0”) starts to blink.

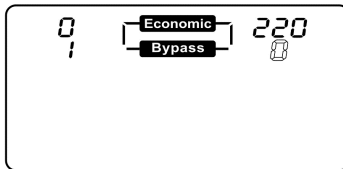

Step 9: Push the Config button to switch the option, which makes “0” switch to “1” and blink.

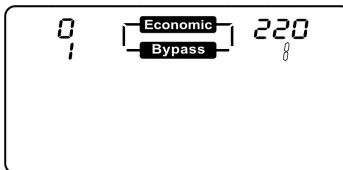

Step 10: Push the Enter button to confirm the option, and then the Generator input type is changed to be enabled. Simultaneously, all the settings are completed.

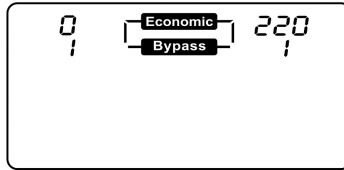

Step 10: Push either the Config button or the Enter button to quit the Config mode.

Note:

- 1) You could press the Enter button once or the Config button twice to skip the single setting item and keep it not changed.
- 2) In Config mode, if interval time between the two buttons pressed is over 30 seconds, the LCD will quit the Config mode automatically.
- 3) In Config mode, if On/Off button is pressed, the LCD will quit the Config mode immediately.

Audible Alarm Introduction—

Condition	Alarm	Sound silence function
Warning for fan failure	Continuously Sounding	Can be silenced
Warning for over temperature	Continuously Sounding	Can be silenced
Warning for battery bad	Continuously Sounding	Can be silenced
Warning for battery overcharged	Continuously Sounding	Can be silenced
Warning for battery disconnected	Sounding every second	Can be silenced
Warning for overload	Sounding every second	Can be silenced
Warning for battery test	Sounding every two seconds	Can be silenced
Warning for Power Failure(Battery Mode)	Sounding every four seconds	Can be silenced
Warning for battery low	Sounding every second	Can't be silenced
Fault for fan failure	Continuously Sounding	Can't be silenced
Fault for over temperature	Continuously Sounding	Can't be silenced
Fault for other failure	Continuously Sounding	Can be silenced

Rear Panel Description CE-certified

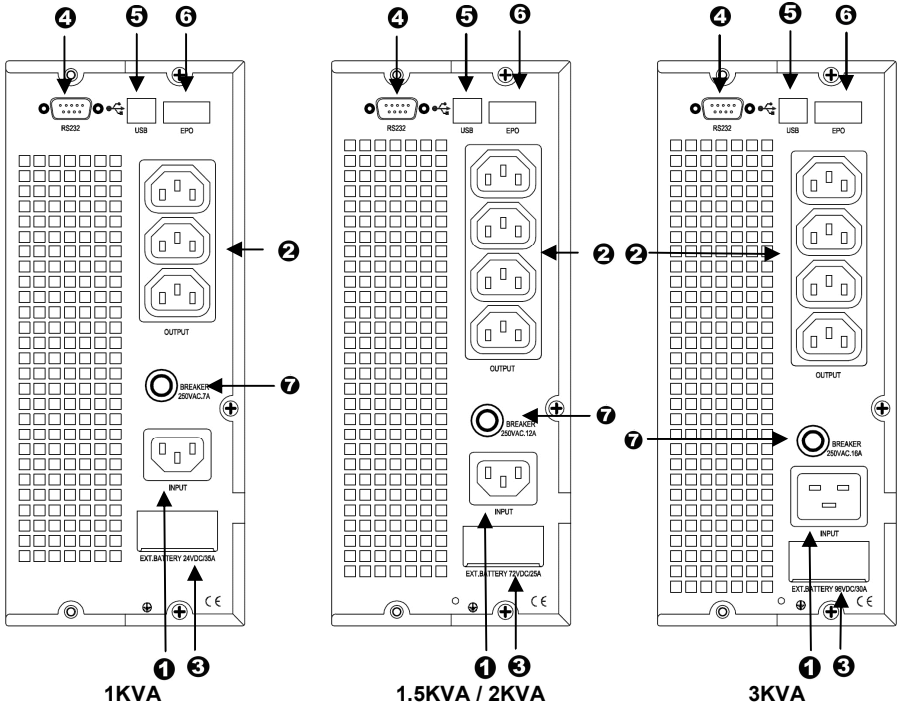

Rear panel description table

- 1: I/P cable
- 2: O/P Socket
- 3: External Battery Connector
- 4: RS232 / DRY-CONTACT
- 5: USB Connector(optional)
- 6: EPO Connector
- 7: I/P Breaker

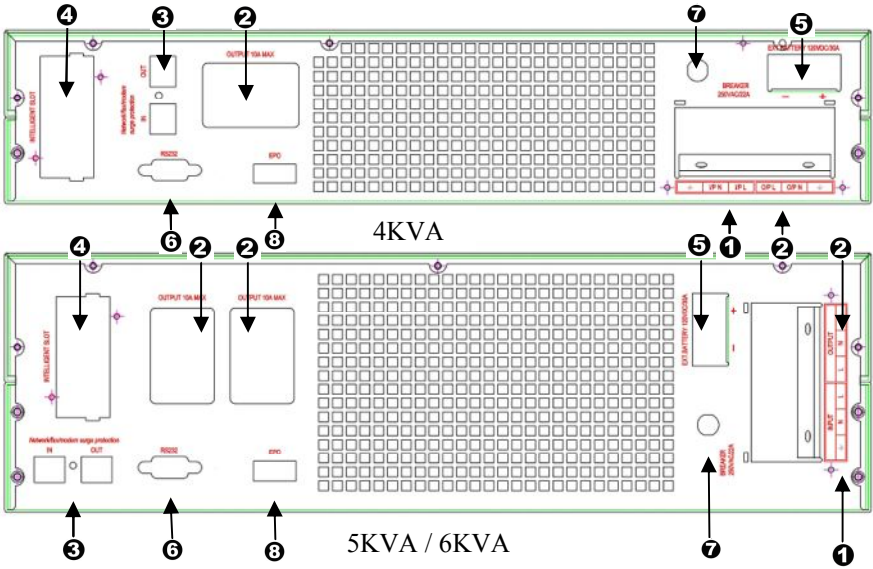

Rear panel description table

- | | |
|-------------------------|-------------------------------|
| 1: I/P Terminal | 5: External Battery Connector |
| 2: O/P Terminal /Socket | 6: RS232 /DRY-CONTACT |
| 3: RJ11/RJ45 | 7: I/P Breaker |
| 4: SNMP Slot | 8: EPO Connector |

Rear Panel Description NON CE-certified

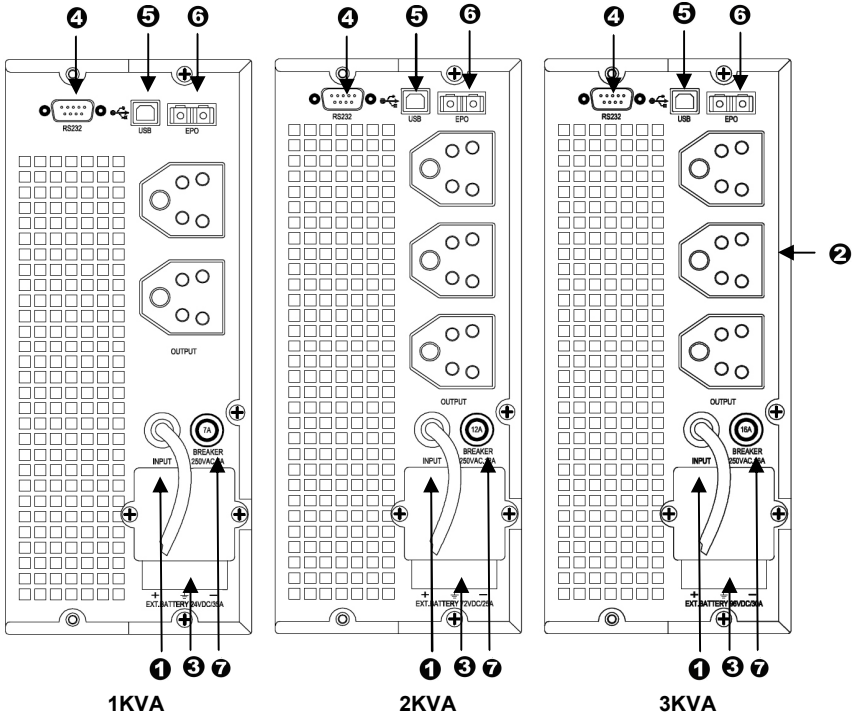

Rear panel description table

- | | |
|-------------------------------|----------------------------|
| 1: I/P cable | 5: USB Connector(optional) |
| 2: O/P Socket | 6: EPO Connector |
| 3: External Battery Connector | 7: I/P Breaker |
| 4: RS232 /DRY-CONTACT | |

4 INSTALLATION

4.1 Inspecting the Equipment

Inspect the UPS upon receipt. If the UPS has been damaged during shipment, keep the box and packing material for the carrier. Notify the carrier and dealer immediately.

4.2 Placement

This UPS should be installed indoors with adequate airflow and free of contamination. Locate it in a clean and indoor environment, free from moisture, flammable liquids, and direct sunlight. Maintain a minimum clearance of 4 inches (100mm); an ambient temperature range must be 0°C to 40°C (32°F to 104°F), and operating humidity range must be 20% to 80% relative humidity (non-condensing).

CAUTION: *The long term uses at ambient temperature in higher than 25°C which should reduce battery life. In addition, place the UPS unit away from the monitor at least 20cm to avoid interference.*

4.3 Charging

This UPS is shipped from the factory with its battery fully charged; however, some charge may be lost during shipping. The battery should be recharged prior to use. Plug the UPS into an appropriate power supply and allow the UPS to charge at least 4 hours.

4.4 Load Connection

Connect one load-related device to each of the power receptacles supplied at the rear of the UPS.

4.5 Modem/Phone-line Connection

Plug incoming telephone line into the “In” socket at the back of the UPS. Use on telephone line cable and plug one end of the telephone line cable to the “Out” socket at the back of the UPS. Plug the other end to the modem input socket.

4.6 DC Start Function

DC Start Function enables UPS to be started up when AC utility power is not available and battery is full charged. Just simply press the On/Off switch to turn on the UPS

4.7 Turn On/Off

To turn on/off the UPS, you should press the on/off switch three seconds at least.

4.8 UPS Setup

All models series are designed for tower and rack purpose. They can be installed as a 19 inch equipment rack, and also can be placed in a tower (with optional stand) as well. Please follow the instruction for Tower Setup or Rack-Mount Setup.

4.9 Tower Setup

This series can be placed in horizontally and vertically. This model is designed in a rack itself. As a tower, it is provided with the optional UPS stand to stabilize the UPS when the UPS is positioned in vertically. The UPS stand must be attached to the bottom of the tower

4.9.1 TOWER CONFIGURATION SETUP

This model is provided with the UPS stand necessary to stabilize the UPS when it's positioned in vertically. The UPS stand must be inserted to the bottom of the tower.

1KVA to 3KVA

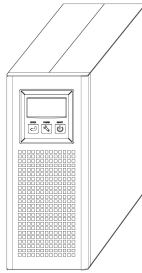

4KVA

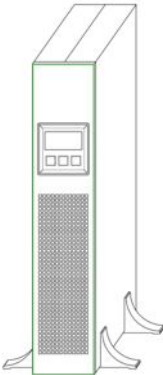

5KVA / 6KVA

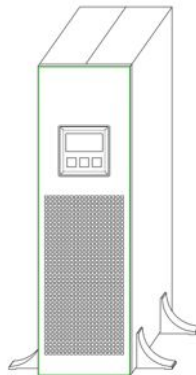

4.9.2 RACK-MOUNT CONFIGURATION SETUP

This UPS can be installed in 19" racks. And the UPS and external battery enclosure need 2U /3U of valuable rack space.

1KVA to 6KVA

1. Align the mounting ears with screw holes on the side of the UPS.
2. Fix the slide to the rack enclosure with screws.
3. Insert UPS into the slide assemblies and lock it in the rack enclosure.

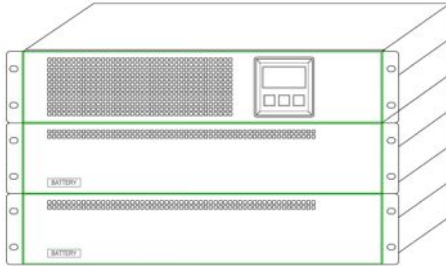

4.9.3 LCD display cover setup

The LCD display of the this model can be rotate to adapt to rack or tower installation. Follow the below steps and charts, you can rotate the LCD display:

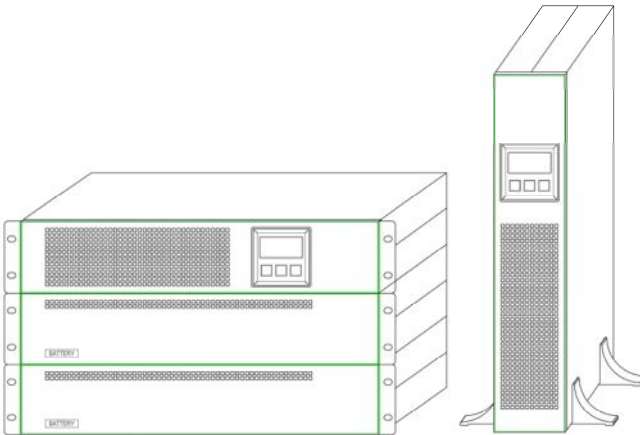

4.9.4 Emergency Power Off(EPO) setup

This UPS includes EPO port that allows power to be shut down the protected equipment immediately and does not follow the shutdown procedure from any power management software.

Note: When EPO switch is reset, the equipment will not return to battery power until the UPS is manually restarted. If pressing power switch to turn off UPS after EPO is activated, the UPS remains in Standby mode when restarted until pressing power switch to turn on the UPS again.

Follow the procedure to install the EPO switch as below.

1. Check the UPS is turned off.
2. Remove the EPO connector from the EPO port on the rear panel of UPS
3. Connect isolated, normally-open, dry contacts (rated to handle 60Vdc maximum, 30Vac RMS maximum, and 20mA maximum) across the EPO device to Pin 1 and Pin 2. Use non-shield wiring, size 18-22 AWG (0.75 mm² – 0.3 mm²).
4. Reconnect the EPO connector to the EPO port.
5. Verify that the externally-connected EPO switch is not activated to enable power to the UPS output receptacles.
6. Plug in the UPS, then pressing power switch “ON/OFF” button to turn on the UPS.
7. Activate the external EPO switch to test the EPO function
8. De-activate the external EPO switch and restart the UPS.

4.9.5 Net/Tel Connection

A telephone/modem or network cable can be connected to the modular RJ-45/RJ11 connectors located on the rear of the UPS. Doing this can protect against overvoltages. A telephone extension cable is required for this type of connection.

NOTICE: The connection is optional. The Net/Tel protection is active even when the UPS is turned off or disconnected from mains power.

CAUTION! The device that protects against over voltage on the telephone line may not work if it is not installed correctly. Ensure that the telephone wall cable is inserted in the connector marked “IN” and that the cable of the unit to be protected (telephone, modem, network card, etc.) is inserted in the connector marked “OUT”.

CAUTION! The overvoltage protection device is only for indoor use. Do not connect telephone wires during a storm.

CAUTION! The protection device limits the effects of an over voltage but does not guarantee overall protection.

5 BATTERY REPLACEMENT



When the Bad Battery indicator flashes and there is a continuous beep, the battery may need to be replaced. Please check the battery connection or contact your local dealer to order new battery.

CAUTION! A battery can present a risk of electrical shock and high short circuit current. The following precautions should be observed before replacing the batteries.

1. Turn off the UPS and disconnect the utility power cord from the wall outlet.
2. Remove rings, watches, and other metal objects.
3. If the battery replacement kit is damaged in anyway or shows signs of leakage, contact your dealer immediately.
4. Properly recycle or dispose of used battery. Do not dispose of batteries in a fire. The batteries may explode.

Note: If you are not qualified service personnel, do not attempt to open the battery door. Please call local dealer or distributor immediately.

Recycle the used battery:

- Never dispose the batteries in a fire. It may explode.
- Do not open or mutilate the batteries. Released electrolyte is harmful to the skins and eyes. It may be toxic. A battery can present a risk of electrical shock and high short circuit current.

CAUTION! Recycle the used battery properly; please do not discard the UPS, battery pack, and batteries into the trash bin. Please follow your local laws and regulations; you may contact your local recycling waste center for further information on the proper disposal of the used UPS, battery pack, and batteries.

6 COMMUNICATION PORT

RS232 + Dry contact:

DB9 Female (RS232 +Dry contact)

PIN #	Description	I/O	Function Explanation
1	Low Battery	Output	Low Battery Output (*normally open, pull to Pin#5 when battery low alarm in battery mode)
2	TxD	Output	TxD
3	RxD	Input	RxD
4	DTR	Input	(tied to pin 6)
5	Common	--	Common (tied to chassis)
6	DSR	Output	(tied to pin 4)
7	RTS	Input	No connection
8	AC Fail	Output	AC Fail Output (*normally open, pull to Pin#5 when UPS is in battery mode).

7 TROUBLE SHOOTING GUIDE

Audible Alarm Trouble Shooting:

Problem	Cause	Solution
Sounding every 4 seconds	The UPS is on battery	Check the input voltage
Sounding every second	The battery is running low	Save your work and turn off your equipment
	Output overload	Check load level display value and remove some load
	Battery may need to charge or service	Replace the battery
Continuously sounding	The UPS fails	Check the LCD display trouble shooting table below

General Trouble Shooting:

Problem	Cause	Solution
The UPS is not on when power switch is pressed	The power cord is not connected correctly	Check the power cord connection
	The wall outlet may be faulty	Please contact your local qualified electrician
	The UPS output may short-circuit or overload	1. Disconnect all loads and ensure nothing is lodged in output receptacles 2. Ensure loads are not defective or shorted internally
	Internal fuse may be blown	Please contact your local dealer
UPS could not provide power to the load	Power presents on one output receptacle	Check the output fuse
	No output from any output receptacle	1. Check the connected cable 2. Ensure the load does not exceed the maximum rating of UPS
Battery has reduced backup time	Battery is not charged	Re-charge the battery at least 24 hours
	Battery may not able to hold a full charge due to age.	1. Recharge the battery at least 8 hours 2. Replace Battery
The UPS fault LCD symbol lights on	The UPS fails	Save your work and turn off equipment. And check the LCD display trouble shooting table above
Connected equipment's lose power while connected to the UPS	The UPS may be over- loaded	Check the load status
	The UPS may be failed	Please contact your local dealer
Buttons does not work	Button is Broken	Please contact your local dealer

8 SPECIFICATION

Model		S1K L	S1K SL	S1.5K L	S1.5K SL	S2K L	S2K SL	S3K L	S3KS L	
Power		1kVA/800W		1.5kVA/1200W		2KVA/1600W		3kVA/2400W		
Input	Input system	Single phase & earth ground								
	Rated voltage	230VAC								
	Voltage range	138V to 300V (0~60% load);138~161V to 300V (60%~80% load);161~184V to 300~286V (80%~100% load)								
	Frequency	50/60 Hz +/- 5 Hz (Auto sensing)								
	Power factor	>0.98 @ full load								
	Voltage range of bypass	230VAC±10%(adjustable)								
Output	Output system	Single phase & earth ground								
	Rated voltage	220/230/240VAC								
	Power factor	0.8								
	Voltage precision	±1%								
	Normal mode	45~55(adjustable)								
	Battery mode	50±0.1Hz								
	Inverter overload Capacity		Line Mode:							
			Over 110% for 2mins,then transfer to bypass and alarm.							
			Over 120% for 1s, then transfer to bypass and turn off output after 1min and alarm							
			Battery Mode:							
			Over 110% for 30s,then turn off output and alarm.							
			Over 120% for 1s, then turn off output and alarm.							
Transfer time	0ms (Normal mode⇌ Battery mode)									
Crest factor	3:1									
Battery	Batteries voltage	24VDC		48VDC		72VDC		96VDC		

	Battery capacity× Quantity	12VDC×2	12VDC×4	12VDC×6	12VDC×8				
	Charge current	2A for Internal batteries; 6A max. (Adjustable)							
	Backup Time	Dependent on the capacity of batteries(Long backup time)							
	Battery charge time	Charger to 90% battery capacity in 3 hours (Standard)							
Dependent on the capacity of external batteries (Long backup time)									
Communi- cate & Interface	Interface port(s)	RS232+Dry contact (DB9)+USB(Optional)							
	Optional cards	SNMP Adaptor							
	LCD display	Information for Load / Battery / Input / Output and Operating Mode							
	Audible alarm	Actively audible alarm for utility failed/ battery low /overload condition							
	Silence switch	Yes							
	EPO	Yes							
Environm- ental	Noise level	<45dB@1Me- ter	<50dB@1Meter						
	Operating temp.	0-1,500m @ 0-40°C / 1,501-3,000m @ 0-35 °C							
	Storage temp.	-20°C ~ 55°C							
	Relative humidity	0 ~ 95% humidity, non-condensing							
	Operating elevation	3,000 meters							
Physical	Installation	Rack & Tower (2-in-1)							
	Dimension (DxWxH)	395x110x260mm(for UPS); 425x110x260(for Battery pack)							
	Net weight (kg)	12	6.5	16	6.7	25	7	30	7.5

MODEL		4KVA	5KVA	6KVA
Topology		On Line Double Conversion		
Input	Support input type	Inverter, generator	Inverter, generator	
	Input voltage range	138V to 300V (0~60% load) 138~161V to 300V (60%~80% load) 161~184V to 300~286V (80%~100% load)		
	Bypass voltage range	230+/-10 %VAC (Adjustable)		
	Input frequency	50/60 Hz +/- 5 Hz (Auto sensing)		
	Input connection	Hard Wire		
	Input power factor	>0.98 @ full load		
Output	VA	4KVA	5KVA	6KVA
	Watt	2800W	3500W	4200W
	Voltage	220/230/240Vac ± 1%		
	Output waveform	Pure Sine Wave		
	Harmonic distortion (Line Mode)	THD< 3% @ linear load THD< =6% @ non-linear load		
	Output frequency (Battery Mode)	50 / 60Hz ±0.1Hz		
	Current crest ratio	3: 1		
	Output connection	Hard wire		
	Overload capacity	Line mode: Over 110% for 2mins, then transfer to bypass and alarm. Over 150% for 1s, then transfer to bypass and turn off output after 1min and alarm. Battery mode: Over 110% for 30s, then turn off output and alarm. Over 120%, for 1s, then turn off output and alarm		
	Transfer time	AC to DC	0 ms	
Efficiency	Inverter mode	>93%		
	Battery mode	>92%		
	ECO mode	>97%		
Battery	Battery type	12V/5Ah*10ea	12V/7Ah*12ea	12V/9Ah*12ea
	Backup time (Full Load)	4min	6min	6min
	Typical recharge time	3 hours to 90% for Internal batteries;		
	Charge current	2A for Internal batteries; 6A max. (Adjustable)		
	Temp. Compensation	Yes		
Communicate & Interface	Interface port(s)	RS232+Dry contact (DB9) /RJ45/SNMP Slot		
	Optional cards	SNMP Card/AS400 Relay Card		
	LCD display	Information for Load / Battery / Input / Output and Operating Mode		
	Audible alarm	Actively audible alarm for utility failed/ battery low /overload condition		
	Silence switch	Yes		
	EPO	Yes	Yes	Yes

MODEL		4KVA	5KVA	6KVA
Environmental	Noise level	<52dB@1Meter	<56dB@1Meter	
	Operating temp.	0-1,500m @ 0-40°C / 1,501-3,000m @ 0-35 °C		
	Storage temp.	-20°C ~ 55°C		
	Relative humidity	0 ~ 95% humidity, non-condensing		
	Operating elevation	3,000 meters		
Physical	Installation	Rack & Tower (2-in-1)		
	Dimension (DxWxH)	454x440x88mm	454x440x132mm	
	Net weight (kg)	12kg	13kg	13.5kg
Others (Only the units with CE markings)	Safety	CE		
	EMC	EN 50091-2 EN 55022 EN 61000-4-2 Level 4 (ESD) EN 61000-4-3 Level 3 EN 61000-4-4 Level 3 EN 61000-4-5 Level 4 (Surge)		

9 SOFTWARE INSTALLATION

WinPower-XP is a brand new UPS monitoring software, which provides user-friendly interface to monitor and control your UPS.

